



Orion-Tr Smart DC-DC Charger Isolated

Table of Contents

1. General Description	1
2. Features	2
3. Safety instructions	3
4. Installation	4
4.1. General	4
4.2. Connection setup for DC-DC converter mode	4
4.3. Connection setup for charger mode	4
4.4. Connection remote on-off	5
4.5. Engine shutdown detection override	6
4.6. Cable and fuse recommendations	7
4.7. Recommended torque	7
5. Engine shuthown detection	8
5.1. Engine shutdown detection sequence	8
5.2. Engine shutdown detection setup with VictronConnect	8
6. LED's	11
7. Troubleshooting	12
7.1. Orion-Tr Smart DC-DC charger error code overview	12
8. Specifications	13
9. VictronConnect - Orion Smart DC-DC Charger	15
9.1. Introduction	15
9.2. Live Data Information	15
9.2.1. Instant Readout over BLE	15
9.2.2. Charger Mode - STATUS tab	15
9.2.3. Charger Mode - GRAPH tab	16
9.2.4. Power Supply Mode	16
9.3. Settings	17
9.3.1. Charger Mode	17
9.3.2. Charger Mode - Battery Settings	17
9.3.3. Power Supply Mode	18
9.4. Product Information	18

1. General Description

The Orion-Tr Smart DC-DC Charger can be used as a power supply or as a battery charger. In charger mode the three-state charge algorithm will increase battery life by properly charging the battery. Especially in the case of vehicles with a smart alternator, or voltage drop caused by long cable runs, controlled charging is indispensable. Controlled charging will also protect the alternator in lithium systems where direct charging can overload the alternator due to the low impedance of the lithium battery. In fixed output mode the output voltage will remain stable independent of the applied load or varying input voltage (within the specified range).

The Orion-Tr Smart DC-DC Charger can be set up to only provide power when the engine is running. This is possible thanks to the built-in engine shutdown detection. This also prevents the onboard voltage of the vehicle from becoming too low. It is not necessary to intervene in the system of the vehicle, to install a separate motor run sensor or to intervene in the CAN-bus system. Apart from this detection, the Orion-Tr Smart DC-DC Charger Isolated can also be activated by a forced allowed to charge feature, e.g. connected to the ignition switch.

The Orion-Tr Smart DC-DC Charger is fully programmable with the VictronConnect App. Discover all setup possibilities in the [VictronConnect manual](#).



2. Features

Smart alternator compatibility

Vehicle manufacturers are now introducing smart ECU (Engine Control Unit) controlled alternators to increase fuel efficiency and reduce emissions. Smart alternators deliver a variable output voltage and are shut down when they're not needed. The converter has an engine running detection mechanism. This prevents the converter from discharging the starter battery when the alternator does not supply power. See section 5 of this manual for more details.

Separation of the starter battery and the service battery

The Orion-Tr Smart DC-DC Charger Isolated separates the starter battery from the service battery when the engine is not running.

Extensive electronic protection

Over-temperature protection and power derating when temperature is high.

- Overload protected.
- Short circuit protected.
- Connector over-temperature protection.

Adaptive three step charging

The Orion-Tr Smart DC-DC Charger Isolated is configured for a three-step charging process:

Bulk – Absorption – Float.

Bulk

During this stage the controller delivers as much charge current as possible to rapidly recharge the batteries.

Absorption

When the battery voltage reaches the absorption voltage setting, the controller switches to constant voltage mode. For lead acid batteries it is important that during shallow discharges the absorption time is kept short in order to prevent overcharging of the battery. After a deep discharge the absorption time is automatically increased to make sure that the battery is completely recharged. For lithium batteries absorption time is fixed, default 2 hours. The fixed or adaptive mode can be chosen on the battery settings and the minimum absorption time for adaptive or fixed absorption time mode is adjustable via VictronConnect.

Float

During this stage, float voltage is applied to the battery to maintain it in a fully charged state. When the battery voltage drops substantially below this level, due to a high load for example, during at least 1 minute, a new charge cycle will be triggered.

Flexible charge algorithm

Programmable charge algorithm, and eight preprogrammed battery settings. Configurable with VictronConnect.

Adaptive absorption time

Automatically calculates the proper absorption time. Configurable with VictronConnect.

Configuring and monitoring

Bluetooth Smart built-in: the wireless solution to set-up, monitor and update the controller using Apple and Android smartphones, tablets or other devices. Several parameters can be customized with the VictronConnect App.

The VictronConnect App can be downloaded from: <https://www.victronenergy.com/support-and-downloads/software>

Use the [VictronConnect manual](#) - to get the most out of the VictronConnect App when it's connected to an Orion Smart.

Input voltage lock-out

Shutdown if the input voltage drops below the lock-out value and restart when the input voltage increases above the restart value. Configurable with VictronConnect.

Remote on-off

Use the remote function to enable and disable the converter remotely with the remote on/off connector or using the VictronConnect App. Typical use cases include a user operated hard wired switch and automatic control by for example a Battery Management System.

3. Safety instructions



SAVE THESE INSTRUCTIONS – This manual contains important instructions that shall be followed during installation and maintenance.



Danger of explosion from sparking

Danger of electric shock

- Please read this manual carefully before the product is installed and put into use
- Install the product in a heatproof environment. Ensure therefore that there are no chemicals, plastic parts, curtains or other textiles, etc. in the immediate vicinity of the equipment.
- It is normal for the Orion Smart DC-DC charger to get hot during operation, keep any objects that are heat-sensitive away
- Ensure that the equipment is used under the correct operating conditions. Never operate it in a wet environment.
- Never use the product at sites where gas or dust explosions could occur
- Always provide proper ventilation during charging
- Avoid covering the charger
- Refer to the specifications provided by the manufacturer of the battery to ensure that the battery is suitable for use with this product. The battery manufacturer's safety instructions should always be observed
- In addition to this manual, the system operation or service manual must include a battery maintenance manual applicable to the type of batteries used.
- Never place the charger on top of the battery when charging
- Prevent sparks close to the battery. A battery being charged could emit explosive gasses.
- This device is not to be used by persons (including children) with reduced physical, sensory or mental capabilities, or lack of experience and knowledge, unless they have been given supervision or instruction.
- Use flexible multistranded copper cable for the connections. The maximum diameter of the individual strands is 0,4mm/ 0,125mm² (0.016 inch/AWG26).
- The installation must include a fuse in accordance with the recommendations in the table "CABLE AND FUSE RECOMMENDATIONS"

4. Installation

4.1. General

- Mount vertically on a non-flammable surface, with the power terminals facing downwards. Observe a minimum clearance of 10 cm under and above the product for optimal cooling.
- Mount close to the battery, but never directly above the battery (in order to prevent damage due to gassing of the battery).

4.2. Connection setup for DC-DC converter mode

1. Disconnect the remote on/off (remove wire bridge).
2. Connect the input supply cables.
3. Open the VictronConnect App to setup the product. **(always adjust the output voltage before connecting in parallel or connecting a battery)**
4. Connect the load. The converter is now ready for use.
5. Reconnect the remote on/off to activate the product.

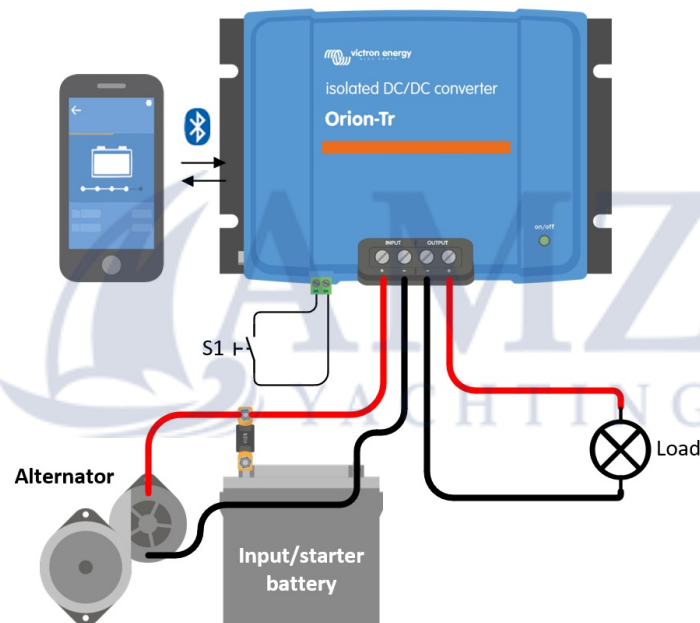

Figure 1: Typical connection setup as DC-DC converter

4.3. Connection setup for charger mode

1. Disconnect the remote on/off (remove wire bridge).
2. Connect the input supply cables.
3. Open the VictronConnect App to setup the product. **(always setup the correct charger algorithm before connecting a battery)**
4. Connect the battery to be charged.
5. Reconnect the remote on/off to activate the product.

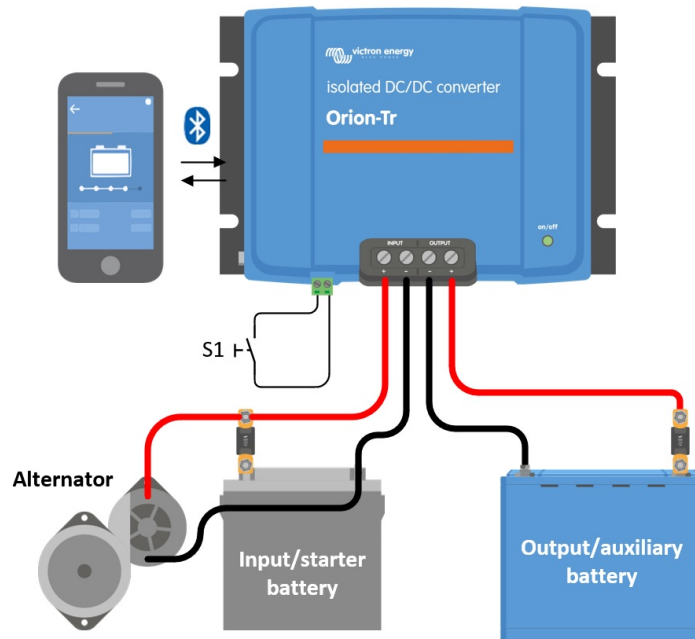

Figure 2: Typical connection setup as charger

4.4. Connection remote on-off

The recommended use of the remote on-off is:

- a) A switch wired between the L-H pins (On-level impedance between L-H pins: < 500kΩ)
- b) A switch wired between (input/starter) battery plus and H-pin (on level: > 3V)
- c) A switch between the L-pin and (input/starter) ground (on level: < 5V)
- d) Isolated remote on-off cable e.g. controlled by a (small)BMS

i Voltage tolerance L & H pin: +/- 70V_{DC}

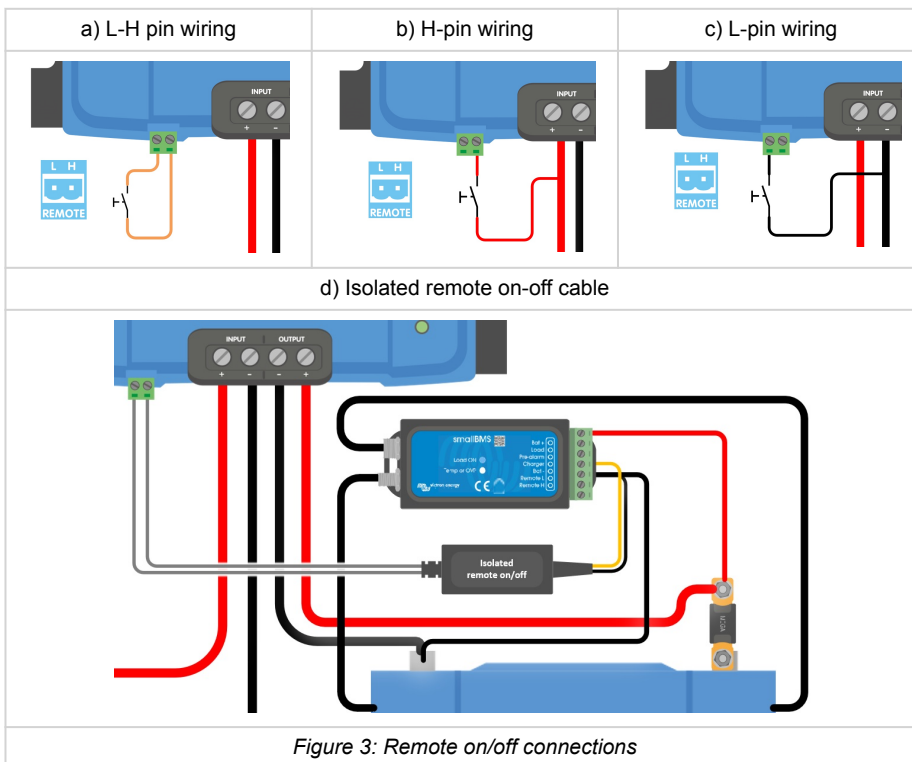

Figure 3: Remote on/off connections

4.5. Engine shutdown detection override

In charger mode the “engine shutdown detection sequence” determines if conditions are met to enable charging, see chapter 5. The “engine shutdown detection override” forces the charger to allow charging independently of the engine shutdown detection. Engine shutdown detection override is activated by applying >7V to the remote L-pin. This allows external control (e.g. ignition switch, CAN bus engine on detector) to enable charging.

i This function does not override the remote on-off function. Remote connection a), b) or d), as shown in Figure 3 must be configured in combination with engine shutdown detection override. See examples in figure 4.

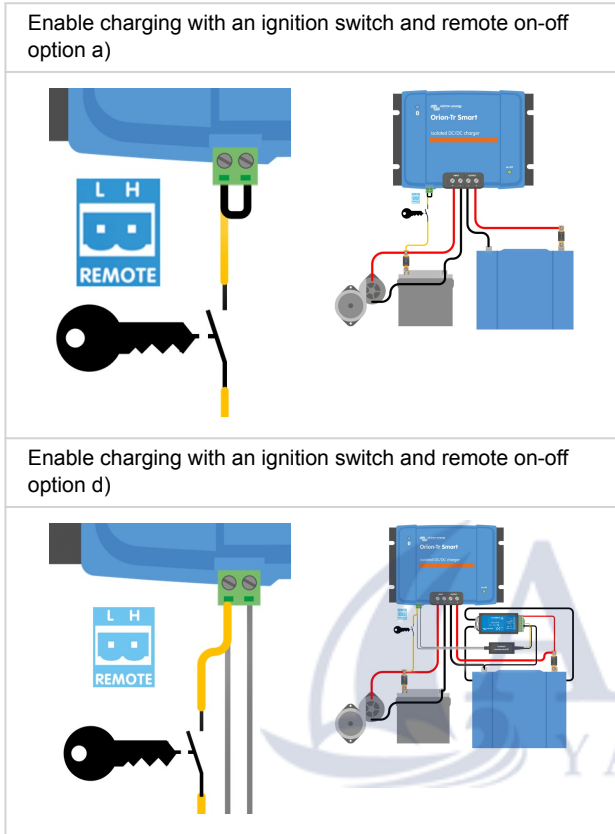

Figure 4: Engine shutdown detection override connection diagram

🔍 If the ignition switch in figure 4 is switched off, the charger will return to “engine shutdown detection” mode, it will not turn off the charger.

To force enable/disable charging (i.e turn the ORION on/off) without the “engine shutdown detection” a remote option as given in chapter 4.4 must be wired, and the engine shutdown detection must be switched off in VictronConnect, see figure 5.

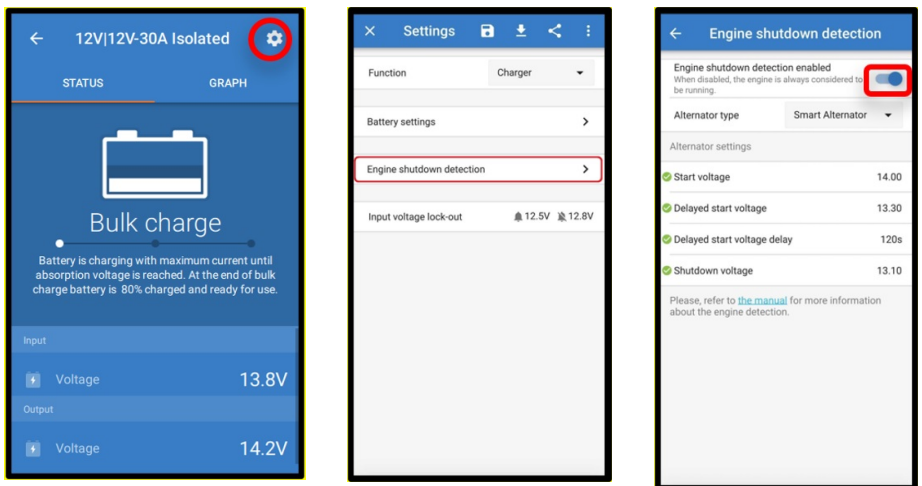



Figure 5: Disable engine shutdown detection

- 

When the engine shutdown detection has been switched off in Victron Connect ('forced charging') **current will be drawn from the starter battery even if the engine is not running.**
- 

During 'forced charging' the input voltage lockout is the only limit left to disable charging automatically, make sure this level is not set too low, in most applications 12.5V is sufficiently low.

4.6. Cable and fuse recommendations

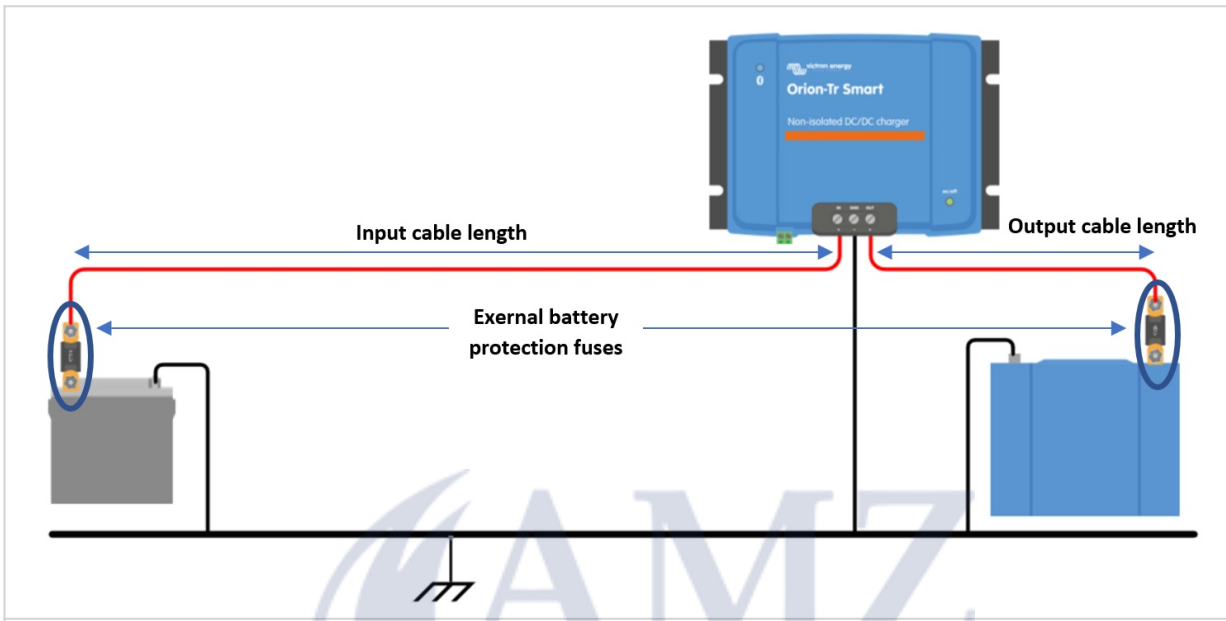
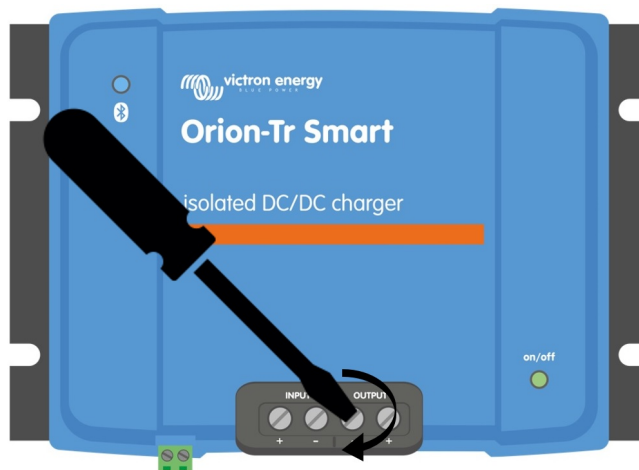

Figure 6: Cable and fuse recommendations

Voltage rating (Input or output)	External battery protection Fuse	Minimum cable gauge				
		0.5m	1m	2m	5m	10m
12 V	60 A	6mm ²	10mm ²	10mm ²	16mm ²	16mm ²
24 V	30 A	4mm ²	6mm ²	6mm ²	10mm ²	10mm ²

4.7. Recommended torque



Torque: 1.6Nm

Figure 7: Tightening torques

5. Engine shutoff detection

The engine shutdown detection mechanism simplifies your ORION-Tr DC-DC Charger system by detecting if the engine is running without wiring additional switches or sensors. The factory default setting will work with most regular and smart alternators but can be re-configured with the VictronConnect App.

Configuring the engine shutdown detection depends on the voltage generated by the alternator when the engine is running. Regular alternators will generate a fixed voltage (e.g. 14V) where smart alternators generate a variable output voltage which can range from 12.5V to 15V. Especially smart alternators in a regenerative braking system show large alternator voltage variations.

Engine shutdown detection is only active in charger mode. The feature can be disabled by the “engine shutdown detection override” and in VictronConnect as shown in figure 5. In power supply mode the “input voltage lock-out” determines when the output is active.



The engine shutdown detection is updated from software version v1.05 onwards.

5.1. Engine shutdown detection sequence

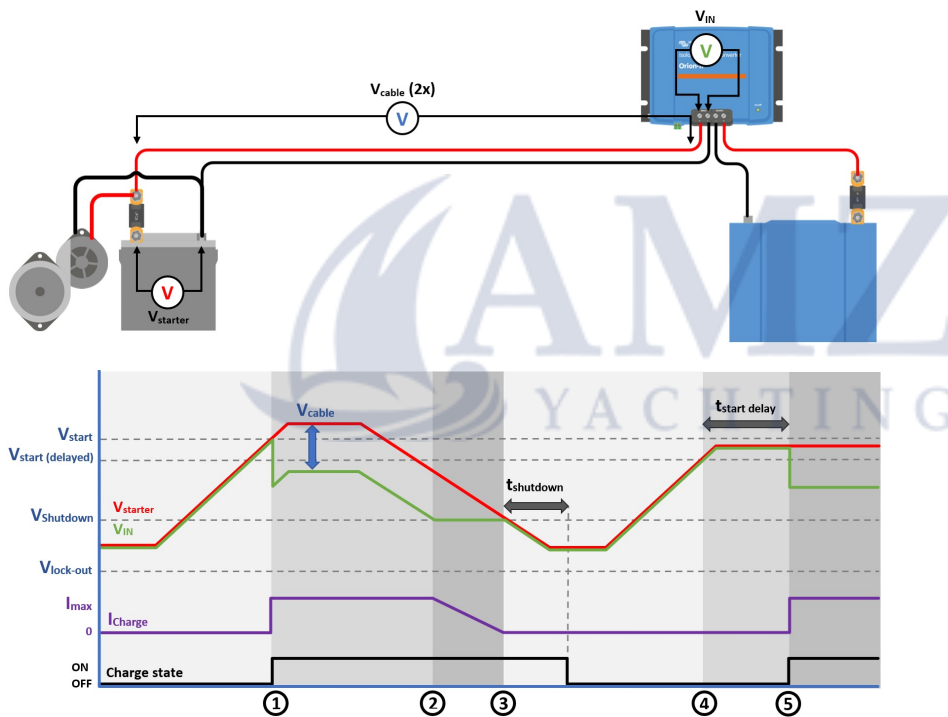

Figure 8: Engine shutdown detection sequence

0 → 1: If the engine runs the alternator voltage will ramp-up, when $V_{\text{starter}} > V_{\text{start}}$, charging is enabled.

1 → 2: The input current produces a voltage across the input cable (V_{cable}); this voltage reduces the voltage measured by the charger (V_{IN}). If $V_{\text{IN}} > V_{\text{shutdown}}$ the charger will operate at I_{max} .

2 → 3: If $V_{\text{IN}} \leq V_{\text{shutdown}}$, the charge current will be reduced to prevent V_{IN} to drop below V_{shutdown} .

3 → 4: If $V_{\text{IN}} < V_{\text{shutdown}}$ for longer than 1min (t_{shutdown}) “engine off” is detected and charging is disabled. If $V_{\text{IN}} > V_{\text{shutdown}}$ before t_{shutdown} runs out, charging remains enabled.

4 → 5: If $V_{\text{start}(\text{delay})} < V_{\text{IN}} < V_{\text{start}}$ charging is enabled after $t_{\text{start delay}}$ (configurable).

5.2. Engine shutdown detection setup with VictronConnect

Open VictronConnect and press the Cog symbol  to enter the settings.

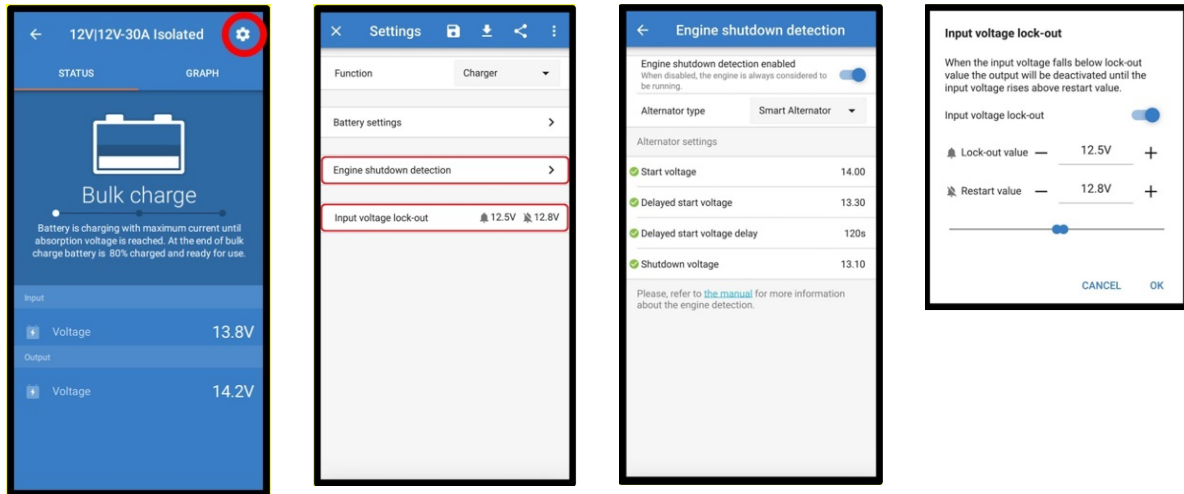

Figure 9: Engine shutdown detection setup menu

The following settings can be changed with VictronConnect:



The default values displayed are for the 12V input models. Those values are scaled depending on the input voltage of the model. E.g. for 24V input models, the default values displayed on the manual should be multiplied by 2.

Engine shutdown detection enabled: The engine shutdown detection is always enabled by default when the charger mode is selected. When it is disabled by the user or when power supply mode is selected, the engine is considered to be running, so no shutdown detection will take place.

Alternator type: The alternator type can be selected between “Smart Alternator”, “Regular Alternator” and “User defined”. When “Smart Alternator” option is selected, the default values for the smart alternator are/will be applied to the engine shutdown detection settings. The same will happen when “Regular Alternator” option is selected. When any of the settings differs from the default values of the last two option, the “User defined” option will be selected. Default: “Smart Alternator”.

Start voltage (V_{start}): At this level charging starts immediately. Default: 14V.

Delayed start voltage ($V_{start(delay)}$): Smart alternators can generate a lower voltage when the engine is running, therefore a lower start level is necessary for these systems. To ensure that the starter battery is recharged after starting the engine, charging of the auxiliary battery is delayed during this condition. The energy used during starting must be replenished to ensure that the starter battery remains properly charged. Default: 13.3V (Smart Alternator) and 13.8 (Regular Alternator).

Delayed start voltage delay ($t_{start\ delay}$): Recharge time for the starter battery during start level (delayed). Example: If the starter draws 150A for 5sec to start the engine, about ~0.2Ah is drawn from the starter battery. If, during engine idling, the alternator can only generate 20A, it takes $150A/20A \times 5sec = 37.5sec$ to recharge the starter battery. Default: 2 minutes.

Shutdown voltage ($V_{shutdown}$): This level corresponds with the engine being off. This keeps the starter battery fully charged and provides a hysteresis with respect to the start level. The hysteresis must be large enough to prevent V_{IN} to drop to $V_{shutdown}$ which would result in charge current reduction. Action will be taken after $t_{shutdown}$ runs out (1 minute); this allows charging during temporary low voltage conditions. Default: 13.1V (Smart Alternator) and 13.5V (Regular Alternator).

Range for engine start/shutdown levels:

- 12|12; 12|24: 8 to 17V
- 24|12; 24|24: 16 to 35V

Setup input voltage lock-out: Input voltage lock-out is the minimum level at which charging is allowed, below this level charging stops immediately. Default (in charger mode): lock-out: 12.5V / restart: 12.8V. Default (in power supply mode): lock-out: 10.5V / restart: 12V.



When ‘forced charging’ is enabled, current will be drawn from the starter battery if the engine is not running. Setting the lock-out level very low can result in a depleted starter battery.

To setup input voltage lock-out two criteria are important:

- **Minimum alternator voltage:** A smart alternator can operate at very low alternator voltage (<12.5V) e.g. when the vehicle accelerates. This low voltage is allowed during $t_{shutdown}$ as shown in “engine shutdown detection sequence 3→4”. If charging must remain enabled during this period, the lock-out level must at least be set below the minimum alternator voltage.



If the low voltage period exceeds tshutdown charging will be disabled on engine shutdown detection.

- **Voltage drop across the input cable:** As seen in “engine shutdown detection sequence 1→3”, V_{IN} will be lowered by V_{cable} . When the alternator voltage drops fast (smart alternator) the charge-control needs some time to reduce charge current and keep V_{IN} at $V_{shutdown}$. During this time V_{cable} must not trip the voltage lock-out. Therefore, the lock-out value should be: $V_{lock-out} \leq V_{shutdown} - V_{cable}$.

Example: Calculate the input cable voltage drop:

- Distance between starter battery and charger: 5m.
- $V_{shutdown} = 13.1V$. Recommended wire gauge: 16mm².
- Cable resistance: $\sim 1.1m\Omega/m$ @20°C, thus $R_{cable} = 1.1m\Omega \times 10m$ (2x 5m) = 11m Ω .
- A 12|12-30A Smart Charger will draw about 35A from the input when running at full capacity, resulting in:
 - $V_{cable} = 11m\Omega \times 35A = 385mV$.
 - $V_{lock-out} \leq V_{shutdown} - V_{cable} = 13.3V - 385mV \approx 12.9V$.



Cable connections, external fuses, temperature, etc. influences the total cable resistance.



6. LED's

The Orion features two LEDs, the blue LED is dedicated to Bluetooth functionality and the green LED indicates the product status as per the list below.

Status LED (Green LED)

- **LED off:**
 - No input voltage
 - Remote shutdown;
 - Shutdown by the user;
 - Connector overtemperature protection
 - User-defined undervoltage lock-out
 - Engine off detected (when in Charger mode)
- **LED on:**
 - Output active on Power supply mode
 - Charger in Float State (Battery charged);
- **LED blinking every 0.8 seconds:**
 - Charger in Bulk or Absorption State (Battery is being charged);

Bluetooth LED (Blue LED)

- **LED off:**
 - No input voltage;
- **LED blinking every 3 seconds:**
 - Error – needs to be checked on VictronConnect; see also [Orion-Tr Smart DC-DC charger error code overview \[12\]](#) for an overview of all Orion error codes displayed in VictronConnect.
- **LED blinking every 0.8 seconds:**
 - Connected via Bluetooth
- **LED blinking every 0.4 seconds:**
 - Identify;
- **LED Blinking once every 5 seconds:**
 - Charger off due to non-error conditions as:
 - Remote shutdown;
 - Shutdown by the user;
 - User-defined undervoltage lock-out;
 - Engine off detected (when in Charger mode);
- **LED on**
 - All other conditions

7. Troubleshooting

7.1. Orion-Tr Smart DC-DC charger error code overview

The error codes are displayed on the VictronConnect app.

For the most up-to-date version of this list see this link: <https://www.victronenergy.com/live/mppt-error-codes>.

Error 2 - Battery voltage too high

- This error will auto-reset after the battery voltage has dropped. This error can be due to other charging equipment connected to the battery or a fault in the charge controller.

Error 26 - Terminal overheated

- Power terminals overheated, check wiring, including the wiring type and type of strands, and/or fasten bolts if possible. This error will auto-reset.

Error 27 - Charger short circuit

- This condition indicates an over-current condition on the battery side. It can occur when a battery is attached to the unit using a contactor. Or in case the charger starts up without a battery connected but connected to an inverter that has a large input capacitance.

This error will auto-reset. If the error does not auto-reset disconnect the charge controller from all power-sources, wait 3 minutes, and power up again. If the error persists the charge controller is probably faulty.

Error 116 - Calibration data lost

- If the unit does not work and error 116 pops up as the active error, the unit is faulty. Contact your dealer for a replacement. If the error is only present in the history data and the unit operates normally this error can be ignored safely. Explanation: when the units power up for the very first time in the factory, it does not have calibration data and an error 116 is logged. Obviously this should have been cleared, but in the beginning units left the factory with this message still in the history data.

Error 119 - Settings data lost

- The charger cannot read its configuration, and stopped.

This error will not auto-reset. To get it working again:

1. First, restore it to factory defaults. (top right in Victron Connect, click on the three dots)
2. Disconnect the charge controller from all power-sources
3. Wait 3 minutes, and power up again.
4. Reconfigure the charger.

Please do report this to your Victron dealer and ask him to escalate it to Victron; as this error should never happen. Preferably include firmware version and any other specifics (VRM URL, VictronConnect screenshots or similar).

8. Specifications

Orion-Tr Smart DC-DC Charger Isolated 220-280 Watt	12/12-18 (220W)	12/24-10 (240W)	24/12-20 (240W)	24/24-12 (280W)
Input voltage range (1)	8-17 V	8-17 V	16-35V	16-35V
Under voltage shut down	7 V	7 V	14V	14V
Under voltage restart	7.5 V	7.5 V	15V	15V
Nominal output voltage	12.2 V	24.2 V	12.2V	24.2V
Output voltage adjust range	10-15 V	20-30 V	10-15V	20-30V
Output voltage tolerance	+/- 0.2 V			
Output noise	2 mV rms			
Cont. output current at nominal output voltage and 40°C	18 A	10 A	20 A	12 A
Maximum output current (10 s) at nominal output voltage	25 A	15 A	25 A	15 A
Short circuit output current	40 A	25 A	50 A	30 A
Cont. output power at 25° C	280 W	280 W	300 W	320 W
Cont. output power at 40° C	220 W	240 W	240 W	280 W
Efficiency	87%	88%	88%	89%
No load input current	< 80 mA	< 100 mA	< 100 mA	< 80 mA
Standby current	Less than 1mA			
Galvanic	200V dc between input, output and case			
Operating temperature range	-20 to +55°C (derate 3% per °C above 40°C)			
Humidity	Max. 95% non-condensing			
DC connection	Screw terminals			
Maximum cable cross-section	16mm ² AWG6			
Weight	1.3 kg (3 lb)			
Dimensions h x w x d	130 x 186 x 70 mm (5.1 x 7.3 x 2.8 inch)			
Standards: Safety	EN 60950			
Emission	EN 61000-6-3, EN 55014-1			
Immunity	EN 61000-6-2, EN 61000-6-1, EN 55014-2			
Automotive Directive	ECE R10-5			

Table 1. Specifications

Orion-Tr Smart DC-DC Charger Isolated 360 – 400 Watt	12/12-30 (360 W)	12/24-15 (360 W)	24/12-30 (360W)	24/24-17 (400W)
Input voltage range (1)	10-17 V	10-17 V	20-35 V	20-35 V
Under voltage shut down	7 V	7 V	14 V	14 V
Under voltage restart	7.5 V	7.5 V	15 V	15 V
Nominal output voltage	12.2 V	24.2 V	12.2 V	24.2 V
Output voltage adjust range	10-15 V	20-30 V	10-15 V	20-30 V
Output voltage tolerance	+/- 0.2mV			
Output noise	2 mV rms			
Cont. output current at nominal output voltage and 40°C	30 A	15 A	30 A	17 A

Orion-Tr Smart DC-DC Charger Isolated 360 – 400 Watt	12/12-30 (360 W)	12/24-15 (360 W)	24/12-30 (360W)	24/24-17 (400W)
Maximum output current (10 s) at nominal output voltage	40 A	25 A	45 A	25 A
Short circuit output current	60 A	40 A	60 A	40 A
Cont. output power at 25°C	430 W	430 W	430 W	480 W
Cont. output power at 40°C	360 W	360 W	360 W	400 W
Efficiency	87%	88%	88%	89%
No load input current	< 80 mA	< 100 mA	< 100mA	< 80mA
Standby current	Less than 1 mA			
Galvanic isolation	200 V dc between input, output and case			
Operating temperature range	-20 to +55° C (derate 3% per °C above 40° C)			
Humidity	Max. 95% non-condensing			
DC connection	Screw terminals			
Maximum cable cross-section	16 mm ² AWG6			
Weight	12 V input and/or 12 V output models: 1.8 kg (3 lb) Other models: 1.6 kg (3.5 lb)			
Dimensions hxwx d	12 V input and/or 12 V output models: 130 x 186 x 80 mm (5.1 x 7.3 x 3.2 inch) Other models: 130 x 186 x 70 mm (5.1 x 7.3 x 2.8 inch)			
Standards: Safety	EN 60950			
Emission	EN 61000-6-3, EN 55014-1			
Immunity	EN 61000-6-2, EN 61000-6-1, EN 55014-2			
Automotive Directive	ECE R10-5			
<p>1) If set to nominal or lower than nominal, the output voltage will remain stable within the specified input voltage range (buck-boost function). If the output voltage is set higher than nominal by a certain percentage, the minimum input voltage at which the output voltage remains stable (does not decrease) increases by the same percentage.</p> <p>Note 1) The VictronConnect App will not display current in or current out.</p> <p>Note 2) The Orion-Tr Smart DC-DC Charger Isolated is not equipped with a VE.Direct port.</p>				

9. VictronConnect - Orion Smart DC-DC Charger

9.1. Introduction

Thank you for using VictronConnect. This guide will help you get the most out of your Orion Smart DC-DC Charger and it requires a minimum knowledge of this charger that can be found in the [introduction](#). The information available here applies to all Orion Smart DC-DC Chargers. To simplify the reference to the Orion Smart DC-DC Charger, it will be referred to as just Orion Smart in this guide.

More general information about the VictronConnect App - how to install it; how to pair it with your device; and how to update firmware, for example - can be found by referring to the overall [VictronConnect manual](#).

Note: Where input and battery voltage is referred to in these instructions, a 12V input and battery is assumed. Please multiply the given values by 2 to arrive at settings for an installation configured for 24V.

9.2. Live Data Information

9.2.1. Instant Readout over BLE

VictronConnect can display key data of the Orion Smart (and other compatible smart products) on the Device list page without the need to connect to the product. This includes visual notifications of warnings, alarms, and errors that enable diagnostics at a glance.

The advantage is:

- Better range than a regular Bluetooth connection
- No need to connect to the smart product
- Key data at a glance
- Encrypted data



Please see the [Instant Readout chapter](#) in the VictronConnect manual for more information and how to set it up.

9.2.2. Charger Mode - STATUS tab

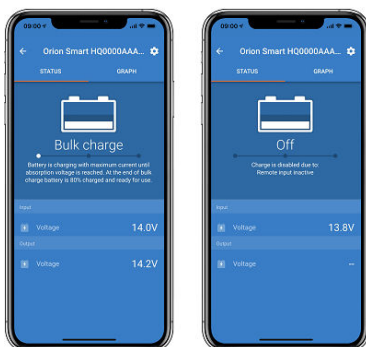

- **Orion Smart [SERIAL NUMBER]** confirms the connected device. A custom name can also be set if desired.
- **Mode icon** shows in which mode the Orion Smart is operating (**Charger** in this case)
- **Charger State:**

- **Bulk:** During this stage the Orion Smart delivers as much charge current as possible to rapidly charge the batteries. When the battery voltage reaches the Absorption voltage setting, the Orion Smart activates the Absorption stage.
- **Absorption:** During this stage the Orion Smart switches to the constant voltage mode, where a pre-set absorption voltage, suitable to the battery type (See *Settings* below), is applied. When the Absorption time is elapsed, the Orion Smart activates the Float stage.
- **Float:** During this stage the float voltage is applied to the battery to maintain a fully-charged state. When the battery voltage drops below Re-bulk voltage during at least 1 minute, a new charge cycle will be triggered.
- **Input Voltage** shows the voltage measured on the input terminals of the device.
- **Output voltage** shows the voltage measured on the output terminals of the device.
 - When the Orion Smart is on Off state, it will not measure the output voltage, so this value will appear as '—'
- **Off Reason** shows the reason why the Orion Smart is disabled (appears under the “Charger State” text when the Orion Smart is Off)

9.2.3. Charger Mode - GRAPH tab

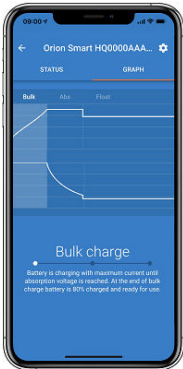

- **Orion Smart [SERIAL NUMBER]** confirms the connected device. A custom name can also be set if desired.
- **Charger State Graph** indicate in which state the charger currently is and show a short description of the current state.

9.2.4. Power Supply Mode



- **Orion Smart [SERIAL NUMBER]** confirms the connected device. A custom name can also be set if desired.
- **Mode icon** shows in which mode the Orion Smart is operating (**Power Supply** in this case)
- **Input Voltage** shows the voltage measured on the input terminals of the device
- **Output voltage** shows the voltage measured on the output terminals of the device
 - When the Orion Smart is on Off state, it will not measure the output voltage, so this value will appear as '—'
- **Off Reason** shows the reason why the Orion Smart is disabled (appears under the “Power Supply Mode” text when the Orion Smart is disabled)

9.3. Settings

VictronConnect allows the user to change and adjust several different settings from the Orion Smart. This is done through the settings option that can be accessed by clicking the  icon on the right top corner of the screen. The settings options are different according to the operation mode that is selected.

9.3.1. Charger Mode

When on Charger Mode, these are the available settings.

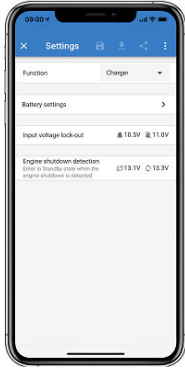

- **Function** allow to choose between “Charger” or “Power supply”. When charger mode is selected, the Orion Smart will follow the three state charge algorithm. For more information about the charge algorithm, please read the [Orion Smart manual](#).
- **Battery settings** allow to change the battery settings in order to adjust the absorption voltage, float voltage and others to fit the battery being charged. The battery setting is explained better on the next item.
- **Input voltage lock-out** allow to choose between two thresholds. One to set the lock-out and another one to reset it. Normally, a minimum 0.5V (for 12V input Orion Smart) difference is used for a better performance. The protection can still be disabled if desired by the user. For more information about the input voltage lock-out, please read the [Orion Smart manual](#).
- **Engine shutdown detection** allow to choose between two thresholds. One to set the detect the engine shutdown and another one to detect when it is running. Normally, a minimum 0.2V (for 12V input Orion Smart) difference is used for a better performance. The engine shutdown detection can still be disabled if desired by the user. For more information about the engine shutdown detection, please read the [Orion Smart manual](#).

9.3.2. Charger Mode - Battery Settings



- **Charger enabled**
 - Toggling this setting turns the Orion Smart off. The batteries will not be charged.
- **Charger settings - Battery preset**
 - Battery preset allows to select the battery type; accept factory defaults; or enter your own preset values to be used for the battery charge algorithm. The Absorption voltage, Float voltage, Bulk time limit, Re-bulk voltage offset, Adaptive absorption time and Absorption time, settings are all configured to a preset value - but can be user-defined.
 - User-defined presets can be stored in the preset library - in this way installers will not have to define all the values each time they are configuring a new installation.
 - By selecting Edit Presets, custom parameters can be set as follows:
 - **Absorption voltage**

- Set the absorption voltage
- **Float voltage**
 - Set the float voltage
- **Bulk time limit**
 - Set the maximum bulk time allowed for the charger.
- **Re-bulk offset voltage**
 - The re-bulk offset voltage determines what is the offset between the float voltage (or absorption if it is lower) and the re-bulk voltage. The re-bulk voltage is the battery voltage threshold that triggers another charge cycle. For example, when the charger cannot maintain the battery voltage due to a high load, the battery voltage will fall and a new charge cycle will be started once the battery voltage drops below the re-bulk voltage.
- **Absorption time**
 - The absorption time depends on whether the adaptive absorption time algorithm is used or not. If **Adaptive absorption time** is not enabled, the charger uses a **Fixed absorption time** that is user selectable and can be set down to 0. Now when the **Adaptive absorption time** is set, the charger will determine the absorption time based on the bulk elapsed time of that charge cycle. The **Maximum absorption time** is also set by the user in this case. The minimum value for this is 30 minutes.

9.3.3. Power Supply Mode

When on Power Supply Mode, these are the available settings.



- **Function** allow to choose between “Charger” or “Power supply”. When power supply mode is selected, the Orion Smart will keep the output voltage as set on the setting.
- **Output voltage** allow to choose the output voltage when power supply mode is selected. Note that the minimum and maximum voltages needs to be within the product limit (i.e.: 10V to 15V for 12V output Orion Smart)
- **Input voltage lock-out** allow to choose between two thresholds. One to set the lock-out and another one to reset it. Normally, a minimum 0.5V (for 12V input Orion Smart) difference is used for a better performance. The protection can still be disabled if desired by the user. For more information about the input voltage lock-out, please read the [Orion Smart manual](#).

9.4. Product Information

By clicking the  button on the top right of the settings menu, it is possible to access the product information screen. See image below.

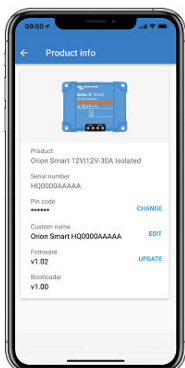

- **Product** shows the Orion Smart model
- **Serial number** shows the serial number of the unit
- **Pin code** allow the pin code to be changed. This is recommended to be done so settings and information won't be easy to access
- **Custom name** allow the product custom name to be changed to what the user wants. As default, it shows a short product name "Orion Smart" plus the serial number
- **Firmware** shows the current firmware version installed on the device and also allow the user to update the charger if desired
- **Bootloader** shows the bootloader firmware version

